

Spherical roller bearings, cylindrical and tapered bore

Principal dimensions			Basic load ratings		Speed ratings		Designation
d	D	B	dynamic C	static C0	Reference speed	Limiting speed	
mm			kN		r/min		* SKF Explorer bearing
180	300	96	1263	1760	1700	2200	23136 CCK/W33 *

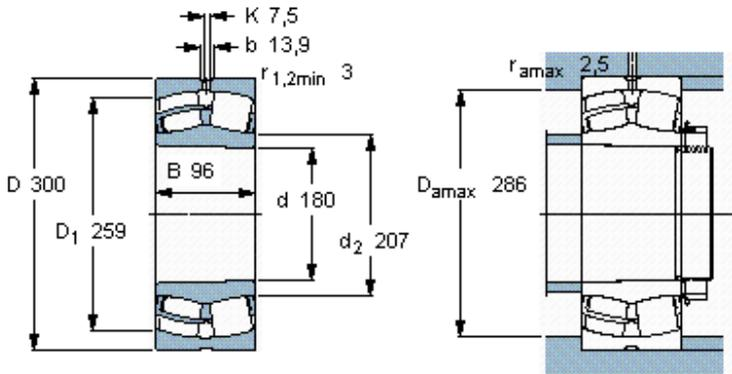

Tapered bore, taper
1: 12

Calculation factors

- e 0,3
- Y_1 2,3
- Y_2 3,4
- Y_0 2,2